



# Low Level CO Monitor Owner's Manual

## Sealed Lithium Battery Powered

### LL6070

Sealed Lithium Battery Powered  
Low Level CO Monitor with LCD  
Digital Display, Single Station

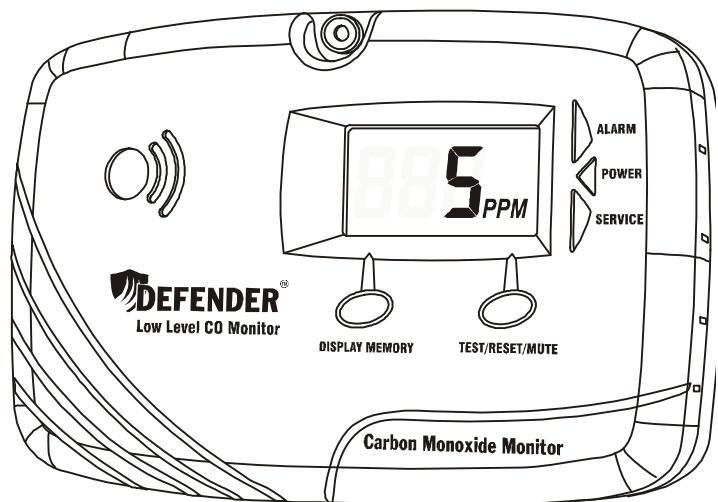

The UL 2034 Standard for Residential Single and Multiple Station Carbon Monoxide (CO) Alarms does not permit UL Listed CO alarms to activate an alarm signal for CO levels below 30 PPM. The Defender LL6070 is designed to provide added protection for the elderly and young children who may be more vulnerable to lower levels of CO, and is not UL Listed. This monitor is intended to supplement, not replace, a UL Listed CO alarm.

# CONTENTS OF THIS MANUAL

1. IMPORTANT MESSAGE AND INSTRUCTIONS
2. WARNING MESSAGES
3. FEATURES AND SPECIFICATIONS
4. INFORMATION ABOUT CARBON MONOXIDE
5. RECOMMENDED LOCATIONS OF MONITORS
6. LOCATIONS TO AVOID
7. INSTALLATION INSTRUCTIONS
8. FUNCTIONS AND OPERATION
9. TEST AND MUTE MONITOR
10. WHAT TO DO WHEN THE ALARM SOUNDS
11. LIMITATIONS OF CARBON MONOXIDE MONITORS
12. GOOD SAFETY HABITS
13. MONITOR END-OF-LIFE AND SERVICE
14. DESCRIPTION OF AUDIBLE AND VISUAL SIGNALS
15. THREE-YEAR LIMITED WARRANTY

## 1. IMPORTANT MESSAGE AND INSTRUCTIONS

**IMPORTANT!** READ ALL INSTRUCTIONS BEFORE INSTALLATION AND SAVE THIS MANUAL FOR FUTURE REFERENCE. *Do not try to repair this CO monitor yourself. Refer to the instructions in Section 13 for service.*

 **CAUTION!** THIS MONITOR WILL ONLY INDICATE THE PRESENCE OF CARBON MONOXIDE GAS AT THE SENSOR. CARBON MONOXIDE GAS MAY BE PRESENT IN OTHER AREAS. THIS CARBON MONOXIDE MONITOR IS DESIGNED TO DETECT CARBON MONOXIDE GAS FROM ANY SOURCE OF COMBUSTION. IT IS NOT DESIGNED TO DETECT SMOKE, FIRE OR ANY OTHER GAS. THIS DEVICE IS DESIGNED TO HELP PROTECT INDIVIDUALS FROM THE EFFECTS OF CHRONIC EXPOSURE TO LOW LEVELS OF CARBON MONOXIDE, THOUGH IT MAY NOT FULLY SAFEGUARD INDIVIDUALS WITH SPECIFIC MEDICAL CONDITIONS. IF IN DOUBT, CONSULT A MEDICAL PRACTITIONER.

 **CAUTION!** CO detection is best achieved by the installation of CO alarms and monitors in all rooms and areas of the residence or facility.

**IMPORTANT!** The monitor must be replaced after five years from installation date. Write the replacement date onto the “REPLACE BY” label affixed to bottom of monitor.

Add the telephone numbers of the local emergency service provider and a qualified technician to the self-adhesive labels provided. Place one label next to the monitor, and the other label near a source of fresh air where you plan to gather when the carbon monoxide monitor signals are activated.

After installation is completed, **TEST** the monitor by pressing the **TEST/RESET/MUTE** button for at least 2 seconds. Detailed testing instructions are outlined in Section 9.

**DO NOT TRY TO TEST THIS MONITOR IN ANY OTHER WAY:** If no alarm sounds, or low or erratic sound emits from the monitor during a test, the unit may be defective and should be returned for service. (See Section 13)

**CLEANING THE MONITOR:** You can clean the monitor by using a vacuum cleaner brush to vacuum around the openings on the monitor. The outside of the monitor may be wiped with a cloth slightly dampened with water only. After cleaning, confirm that the green power LED flashes once every 60 seconds (see Operation in Section 8), and test the monitor by operating the **TEST/RESET/MUTE** button.

**DO NOT PAINT ON OR NEAR THE MONITOR:** The paint will damage the sensor or block the vents and affect the monitor function.

**DO NOT SPRAY AIR REFRESHENER, CLEANING SUPPLIES, OR INSECT KILLER ON OR NEAR THE MONITOR:** Certain kinds of aerosol chemicals will damage the sensor and cause improper operation. The dwelling must be well ventilated when using cleaning supplies or similar contaminants.

## 2. WARNING MESSAGES

 **WARNING!** Actuation of this device indicates the presence of carbon monoxide (CO) which can KILL YOU.

 **WARNING!** Test the CO monitor at least once a week

 **WARNING!** Test the CO monitor immediately after the residence or facility has been vacant.

 **WARNING!** The loudness of the alarm sound may cause you to feel uncomfortable. Cover the horn opening with the palm of your hand to reduce the volume while testing the monitor.

 **WARNING!** Constant exposures to high or low temperature, or high humidity, may shorten battery life.

### 3. FEATURES AND SPECIFICATIONS

- Factory Sealed Lithium Batteries with Soldered Connections
- Accurate and Reliable Water-Based Electrochemical Sensor
- Integrated Filter for Removing Nuisance Gases
- Samples for Carbon Monoxide (CO) Every 5 Seconds
- Extra-Large Alpha Numeric LCD Readout
- Continuously Displays CO Levels Detected of 5 PPM or more
- Automatic Visual Alert Signals at 10 PPM
- Automatic Audible and Visual Alarm Signals at 15 PPM
- Manually Displays Peak CO Levels Detected of 5 to 500 PPM
- Manually Displays Duration of Peak CO Level
- Separate Memory and Test Buttons
- Separate Alarm, Power and Service LED's
- Integrated Battery Activation/Deactivation Switch
- Self Diagnostic Circuitry and Sensor Life Monitor
- Secure-Lock™ Mounting System
- Three Year Limited Warranty for Monitor and Batteries

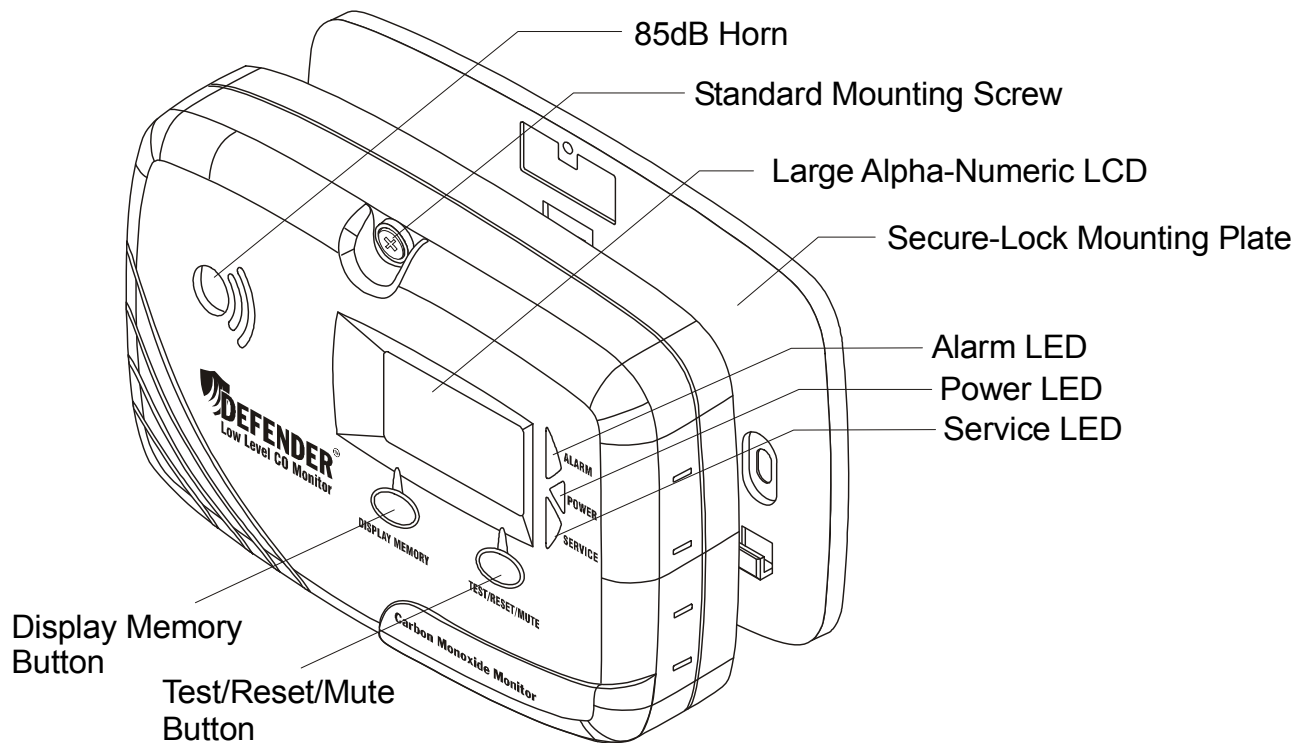

## SPECIFICATIONS

### Visual CO Alert Signals

#### 5 - 9 PPM ≤ 1 minute:

Continuously displays current CO level detected of 5 PPM or more.

#### 10 - 14 PPM ≤ 10 minutes:

Displays CO level, and “Alarm” red LED flashes 4 times every minute. Reset button suspends flashing red LED for 24 hours. Suspension is overridden and audible and visual alarm signals are immediately activated if CO level rises above 14 PPM.

### Visual and Audible CO Alarm Signals

#### 15 - 24 PPM ≤ 60 minutes:

Displays CO level, beeps 4 times every minute, and “Alarm” red LED flashes in sync with beep.

#### 25 - 49 PPM ≤ 30 minutes:

Displays CO level, beeps 4 times every 5 seconds for 5 minutes then beeps 4 times every minute, and “Alarm” red LED flashes in sync with beep.

#### 50 - 99 PPM ≤ 15 minutes:

Displays CO level, beeps 4 times every 5 seconds for 5 minutes then beeps 4 times every minute, and “Alarm” red LED flashes in sync with beep.

#### 100 - 149 PPM ≤ 4 minutes:

Displays CO level, beeps 4 times every 5 seconds for 5 minutes then beeps 4 times every minute, and “Alarm” red LED flashes in sync with beep.

#### 150 - 500 PPM ≤ 2 minutes:

Displays CO level (above 500 PPM, flashes “500 PPM”), beeps 4 times every 5 seconds for 5 minutes then beeps 4 times every 20 seconds, and “Alarm” red LED flashes in sync with beep.

### Audible Mute Duration:

15 - 24 PPM: Mute button silences audible alarm signal for 12 hours; “Alarm” red LED continues to flash 4 times every minute. Mute is overridden and audible signal reactivated within 1 minute if CO level rises above 24 PPM

25 - 49 PPM: Mute button silences audible alarm signal for 5 minutes; “Alarm” red LED continues to flash 4 times every minute. Mute is overridden and audible signal reactivated within 1 minute if CO level rises above 49 PPM

50 - 99 PPM: Mute button silences audible alarm signal for 5 minutes; “Alarm” red LED continues to flash 4 times every minute. Mute is overridden and audible signal reactivated within 1 minute if CO level rises above 99 PPM

100 - 500 PPM: Mute function is disabled

**Sensor Type:**

Electrochemical

**Operating Temperature and Humidity:**

40°F to 100°F @ 10% to 95% RH

**Audible Signal:**

Buzzer Horn Sounds 85 dB at 10 feet

**Visual Signals:**

- Green LED Indicates Power On
- Alarm Red LED Indicates CO Alert or Alarm
- Service Red LED Indicates Service Required

**Detection Frequency:**

Samples for CO every 5 seconds

**LCD Digital Display:**

- Automatically Displays Current CO Level Detected from 5 to 500 PPM
- Manually Displays Highest CO Level Detected from 5 to 500 PPM
- Manually Displays Duration of Peak CO Level from 0 to 999 minutes
- Display Resolution 1 PPM
- Display Accuracy  $\pm 15\%$  or 5 PPM, whichever is greater, @ 50% RH, 72°F  $\pm 5^\circ$
- The accuracy of the display below 30 PPM is an estimate for the first year only.
- The sensor and display accuracy may be affected by environmental conditions and other circumstances beyond manufacturer's control.

**Sensor Life Monitor**

Activates sensor expiration signal after five years of operation

**Factory Sealed Lithium Batteries**

Two non-replaceable, non-removable lithium batteries for up to five years of operation under normal conditions

**Electrical Rating:**

6VDC

## 4. INFORMATION ABOUT CARBON MONOXIDE

### WHAT IS CARBON MONOXIDE?

Carbon monoxide (CO) is a highly toxic, invisible, odorless, tasteless gas.

### HOW IS CO GENERATED?

Carbon monoxide is generated through incomplete combustion of fuel in various appliances. Faulty ventilation of furnaces, water heaters, fireplaces, wood burning stoves, and space heaters are the major cause of high CO levels in a building. Automobile and small engine exhaust are another source of CO.

### HOW DOES CO POISON PEOPLE?

The human body depends on oxygen for the burning of fuel (food) to provide us with the energy that allows our cells to live and function. Oxygen makes up approximately 21% of the atmosphere and enters our lungs when we breathe. In our lungs the oxygen combines with the hemoglobin in the blood (oxyhemoglobin), and is carried in the blood stream throughout the body where it releases oxygen to the cells.

Carbon monoxide is dangerous because it bonds more tightly to the hemoglobin (carboxyhemoglobin, COHb) than oxygen does. When CO combines with hemoglobin, the hemoglobin's ability to combine with oxygen is lost. As the COHb concentration rises, people become nauseous, unconscious and ultimately die (see below).

### WHAT ARE THE SYMPTOMS OF CARBON MONOXIDE POISONING?

Many people often confuse carbon monoxide poisoning with the flu; the initial symptoms being very similar. Different concentrations of CO over various lengths of time cause different symptoms.

The following symptoms may be related to *CARBON MONOXIDE POISONING* and should be discussed with EVERYONE.

<b>MILD EXPOSURE:</b>	Headaches, running nose, sore eyes, often described as "flu-like" symptoms.
<b>MEDIUM EXPOSURE:</b>	Dizziness, drowsiness, vomiting.
<b>EXTREME EXPOSURE:</b>	Unconsciousness, brain damage, death

Many cases of CARBON MONOXIDE POISONING indicate that while victims are aware they are not well, they become so disoriented that they are unable to save themselves by either exiting the building or calling for assistance.

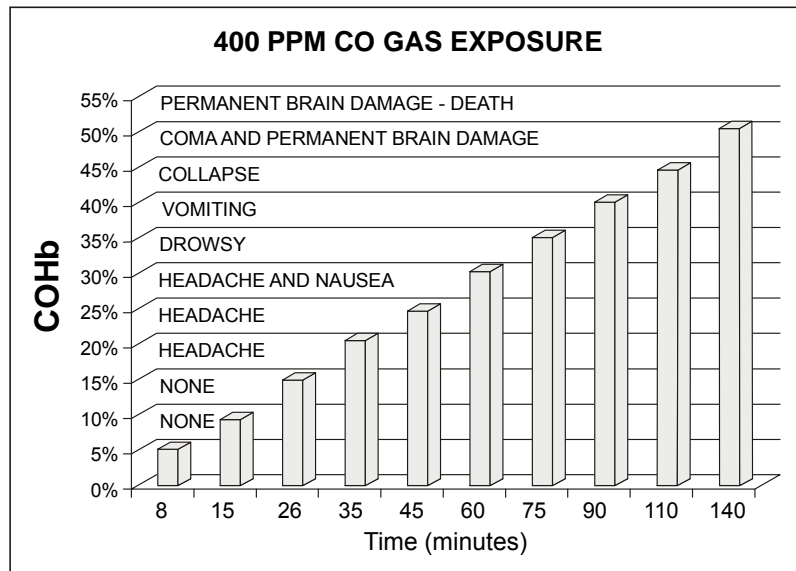

## 5. RECOMMENDED LOCATION OF MONITORS

The Consumer Products Safety Commission (CPSC) recommends the use of "at least one CO alarm per household located outside each sleeping area." (See diagrams "A" and "B").

CO poisoning can happen anywhere in the building, but because most CO poisoning cases occur while people are sleeping, the best location for a CO alarm and CO monitor is near or within the sleeping area in the residence or facility. If there is more than one floor or sleeping area, or if bedroom doors are closed during the night, you may need more than one CO alarm and monitor.

Carbon monoxide at room temperature [68°F] is slightly lighter than air (density of CO 0.96716 compared to air). CO alarms and monitors should be mounted five feet off floor, or at eye level, for best operation and to easily test and view display.

1. Install the first alarm in the immediate area of the bedrooms. If more than one sleeping area exists, locate additional alarms near each sleeping area.
2. Install an alarm inside every room where someone sleeps with the door closed. The closed door may prevent the alarm from waking the sleeper.
3. Install a monitor inside every bedroom that is occupied by someone who may be hypersensitive to CO, such as the elderly, children or pregnant women.
4. Install a monitor where a supervisor, caretaker or parent will see and hear any alert or alarm activation, day and night.
5. Install an alarm and monitor on every level of the building (see diagrams "A" and "B")

Carbon monoxide alarms that are Listed to the UL 2034 Standard, like the Defender CA6150, should be installed in every residence, nursing home and daycare facility, according to the manufacturer's instructions.

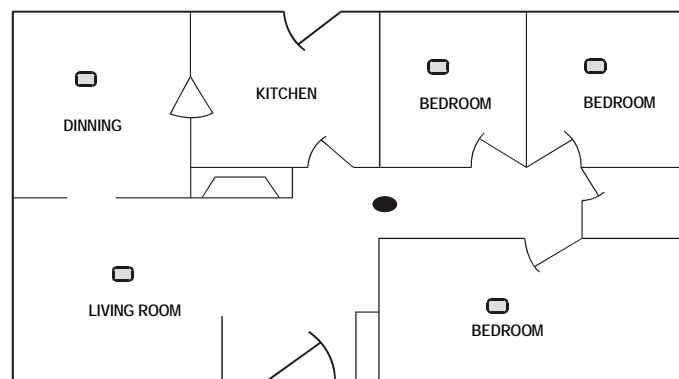
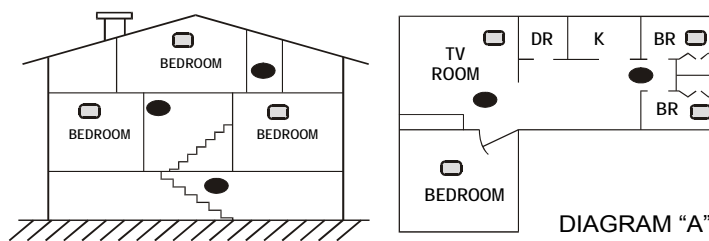

- Recommended CO alarm location for minimum protection.
- Additional CO monitor location for added protection.



## 6. LOCATIONS TO AVOID

**NEAR THE COOKING AREA:** Do not install the monitor within five feet of cooking appliances. CO may be generated in the cooking process and cause nuisance alarms. Also, cooking grease can build up on the monitor and cause monitor failure.

**WITHIN FIVE FEET OF A FURNACE, WATER HEATER, OR SPACE HEATER:** These devices often spill out small amounts of CO when they first turn on.

**IN GARAGES:** Automobile exhaust contains CO and will activate alarm.

**IN DUSTY AREAS:** Dust can build up on monitor and prevent it from working properly.

**IN CLEANING SUPPLY ROOMS:** Cleaning chemicals and painting supplies may cause nuisance alarms.

**IN UTILITY OR BATH ROOMS:** Do not install the monitor inside or within three feet of a room with a bathtub, shower, spa or washer/dryer. Excessive moisture may cause nuisance alarms.

**IN VERY HOT OR COLD AREAS:** Do not install monitor on any exterior wall or in areas which are below 40°F or above 100°F.

**IN DEAD AIR SPACE:** Do not install monitor within one foot of where wall meets ceiling or floor.

**IN HAZARDOUS LOCATIONS:** This monitor is not suitable for installation in a hazardous location, as defined in the National Electrical Code.

**NEAR WIRELESS DEVICES:** Do not install the monitor within one foot of wireless devices. Radio Frequencies (RF) may interfere with the CO monitor's proper operation.

## 7. INSTALLATION INSTRUCTIONS

Follow these steps in this order to install the monitor:

1. Review Section 5, **RECOMMENDED LOCATIONS OF MONITORS**
2. Review Section 6, **LOCATIONS TO AVOID**
3. Fasten the mounting plate to the wall at eye level. Slide monitor down onto mounting plate. The monitor will be automatically activated.
4. It is important that you use the mounting plate provided. If the mounting plate is not used, you must slide the activation switch at the back of monitor to the left until it meets the Stop, ON position, as in diagram (D).
5. Once activated, the CO monitor should operate for up to five years without battery replacement.
6. Press and hold test button until monitor starts to beep, then release. The monitor should beep 4 times, pause, then beep 4 times again. Alarm Red LED should flash at the same time.
7. Secure monitor to mounting plate, with Phillips head screw provided, through the mounting hole on top of monitor (a tamper-proof screw may be used if required).
8. Be sure that the monitor is not obstructed by bedding, furniture, drapes, etc.

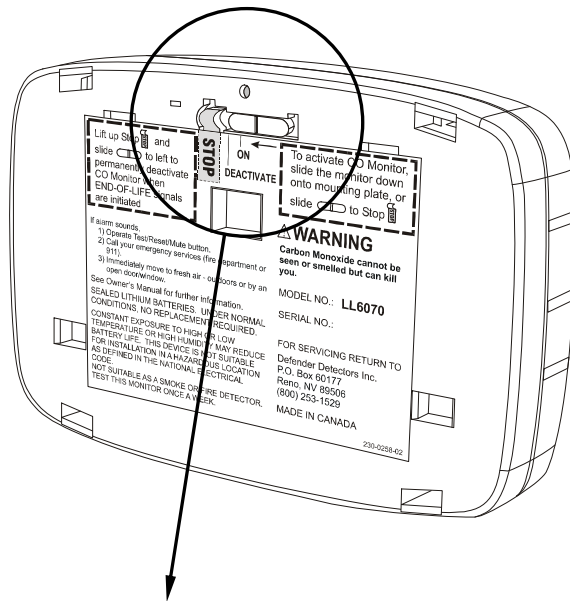

(C) Activation switch is not initially in ON position

Mounting hole is closed when switch is in initial position

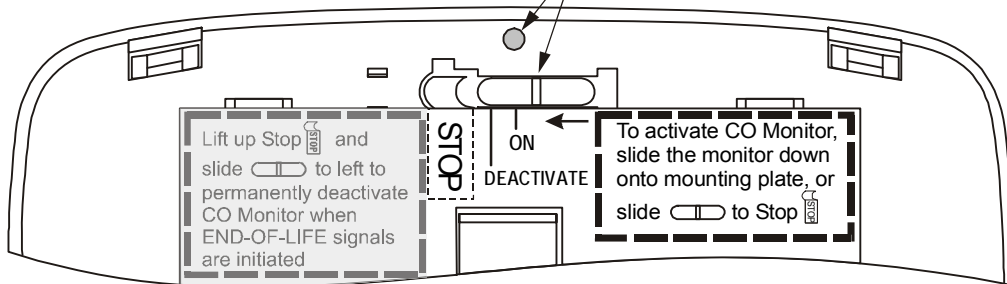

(D) Monitor is activated when switch is in ON position

Mounting hole is open when switch is in ON position

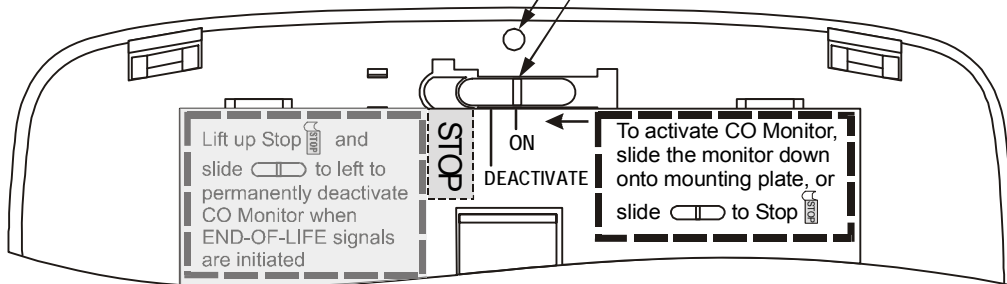



If the activation switch is not set to ON position, as in diagram (D), the mounting hole at top of monitor will be blocked, and the CO monitor will not be activated.

The model LL6070 is a sealed lithium battery powered wall mounted Low Level CO Monitor. Two lithium battery cells are permanently sealed with soldered connections, and cannot be removed. No battery replacement is required, and the factory sealed batteries should power the monitor for up to five years under normal operation.

## 8. FUNCTIONS AND OPERATION



**OPERATION:** The CO monitor is operational once the activation switch is slid to ON position. If the monitor's power is active, the green LED will flash once every 60 seconds. The LCD readout will continuously display 0 PPM, or the current CO level if 5 PPM or more is detected.

**LOW BATTERY CONDITION:** When battery voltage drops below an acceptable level, the monitor will chirp once per minute and green LED will blink 5 seconds every minute. The LCD will also display  symbol and 0 PPM, or current CO level if 5 PPM or more is detected. See Section 13 for information regarding service.

**SERVICE CONDITION:** An internal microcontroller continuously monitors the sensor function and other critical components. If an internal failure of any of these components should occur, the monitor will chirp twice (BEEP - BEEP) per minute, **SERVICE** red LED will blink for 5 seconds every minute, and LCD will continuously display . This malfunction condition indicates a problem with the unit. See Section 13 for information regarding service.

**END-OF-LIFE CONDITION:** The electrochemical sensor has a five year life expectancy. Once the batteries are activated, a microcontroller monitors the total time that the monitor is under power. After five years of service, the "End-of-Life" signal will be activated to indicate that the sensor life has expired and the monitor must be replaced; the LCD will continuously display , monitor will chirp once per minute and **SERVICE** red LED will glow for 3 seconds at the same time. See Section 13 for handling an End-of-Life signal.

**ALARM CONDITION:** When the batteries are active, and CO gas is detected at a level and duration specified in Section 3, the horn will sound and **ALARM** red LED will light. The alarm signal will sound 4 short beeps every minute for CO levels detected between 15-24 PPM, or every 5 seconds if over 24 PPM. The **ALARM** red LED will flash in sync with the beeping sound. The LCD will also display the current CO level detected. After having alarmed for more than 5 minutes, the alarm signal will change to 4 short beeps every 60 seconds for CO levels detected between 15-149 PPM, or every 20 seconds for CO levels detected of 150-500 PPM or more. The alarm signal is either manually or automatically reset. See Section 10 **WHAT TO DO WHEN THE ALARM SOUNDS**.

**TEST/RESET/MUTE BUTTON:** The **TEST/RESET/MUTE** button is used to check the monitor for proper operation, and to temporarily mute horn for 12 hours when alarm is activated at CO levels between 15-24 PPM, or 5 minutes if over 24 PPM. The mute feature is disabled if CO levels reach 100 PPM or more. A "Low Battery Voltage" signal () can be muted for 24 hours during first week of activation. The sensor "End-of-Life" signal () can be muted for 60 hours during first month of activation. The LCD will display current CO level if 5 PPM or more is detected while monitor is tested, or  for 5 seconds when an alarm signal is muted. See Section 9 for detailed instructions to test the monitor and mute the audible horn.

**LCD DISPLAY FUNCTION:** When monitor is operating normally, the LCD will display 0 PPM or the current CO level if 5 PPM or more is detected. Above 500 PPM, the LCD will flash "500 PPM". The LCD will display  symbol if batteries have low voltage.

**DISPLAY MEMORY BUTTON:** To manually display the highest CO level detected, press the **DISPLAY MEMORY** button once. The LCD will display the recorded data in the following order:





1. The highest CO level detected from 5 to 500 PPM.
2. The total length of time the monitor has detected the highest CO level, within 10% of the peak, from 0 to 999 minutes.

Each reading will appear for five seconds. To erase the record in memory, press the **TEST/RESET/MUTE** button when the readings are displayed. The monitor will burst a long beep, and the display reads .

## 9. TEST AND MUTE MONITOR

To test the monitor, press the **TEST/RESET/MUTE** button on the cover and hold it down for a minimum of 2 seconds or until the monitor starts beeping and **ALARM** red LED flashes, then release. This test will simulate a CO concentration of approximately 100 ppm CO gas. If all of the electronic circuitry and buzzer are working correctly, the monitor will sound 4 short beeps and will flash red **ALARM** LED at the same time, followed by a 5 second pause, and then repeat 4 more short beeps with flashing red LED.

To mute the audible horn during an alarm signal, press the **TEST/RESET/MUTE** button. The **ALARM** red LED will flash 4 times, display will read  for 5 seconds, and horn will be temporarily silenced. The audible and visual alarm signals will be automatically reactivated within 12 hours if a CO level of 15-24 ppm continues to be detected, or within 5 minutes if 25 ppm or more. The alarm mute feature is disabled at CO levels of 100 PPM or more. See Section 10 **WHAT TO DO WHEN THE ALARM SOUNDS**.

To mute the audible horn during a low battery signal () condition, press the **TEST/RESET/MUTE** button. The green LED will blink for 5 seconds, monitor will display  at the same time, and horn will be temporarily silenced for 24 hours. The LCD will continuously display low battery signal symbol , and current CO level if 5 PPM or more is detected. When the audible signal reactivates, you can continue to mute the horn for an additional 24 hour period by again pressing the **TEST/RESET/MUTE** button. The horn can only be turned off during the first 7 days of a low battery signal activation. After 7 days, the monitor will return to its normal low battery signal condition; 1 chirp per minute, green LED blinks for 5 seconds, continuously displays .

To test the monitor during a low battery signal condition, press and hold **TEST/RESET/MUTE** button for minimum 2 seconds when audible signal is not sounding.

To mute the audible signal during an “End-of-Life” condition, press the **TEST/RESET/MUTE** button. The **SERVICE** red LED will glow for 5 seconds, monitor will display  at the same time, and horn will be temporarily silenced for 60 hours. When the audible signal reactivates, you can continue to mute the horn for an additional 60 hour period by again pressing the **TEST/RESET/MUTE** button. The horn can only be turned off during the first 30 days of the “End-of-Life” signal activation. After 30 days, the monitor will return to its normal “End-of-Life” condition; 1 chirp per minute, **SERVICE** red LED glows for 5 seconds at the same time, and continuously displays “End”.

To test the monitor during an “End-of-Life” condition, press and hold **TEST/RESET/MUTE** button for minimum 2 seconds when audible signal is not sounding.

The audible signal cannot be muted when monitor is in **SERVICE** condition; monitor chirps twice (BEEP - BEEP) per minute, **SERVICE** red LED blinks for 5 seconds, and continuously displays **Err**. See Section 13 for information regarding service.

## 10. WHAT TO DO WHEN THE ALARM SOUNDS

If alarm signal sounds:

- 1) Operate **TEST/RESET/MUTE** button;
- 2) Call your emergency services (tel. no. \_\_\_\_\_)  
[fire department or 911];
- 3) Immediately move to fresh air - outdoors or by an open door or window. Do a head count to check that all persons are accounted for. Do not re-enter the premises or move away from the open door/window until the emergency services responders have arrived, the premises have been aired out, and the monitor remains in its normal condition.
- 4) After following steps 1- 3, if the alarm reactivates within a 24 hour period, repeat steps 1-3 and call a qualified appliance technician:  
(telephone no. \_\_\_\_\_)  
to investigate for sources of CO from fuel burning equipment and appliances, and inspect for proper operation of this equipment. If problems are identified during this inspection, have the equipment serviced immediately. Note any combustion equipment not inspected by the technician and consult the manufacturers' instructions, or contact the manufacturers directly, for more information about CO safety and this equipment. Make sure that motor vehicles are not, and have not been, operating in an attached garage or adjacent to the residence or facility.

**MANUAL RESET:** You can temporarily silence an audible alarm signal by pressing the **TEST/RESET/MUTE** button. The **ALARM** red LED will flash 4 times, display **OFF** for 5 seconds, and then continue to display the current CO level detected from 5 to 500 ppm. The audible and visual alarm signals will be automatically reactivated within 12 hours if a CO level of 15-24 ppm continues to be detected, or within 5 minutes if 25 ppm or more. Do not wait to see if the alarm is reactivated; follow above instructions immediately. The alarm mute feature is disabled at CO levels of 100 PPM or more.

**AUTOMATIC RESET:** If a CO alarm activation is not manually reset, the horn will sound for at least 5 minutes. After 5 minutes, the alarm will automatically reset itself and return to normal operation if the CO which caused the alarm activation has cleared.

**If the residence or facility has been temporarily vacant and you return to find the monitor(s) sounding, do not enter the building. Call the Fire Department from another location. Do not re-enter the building for any reason until you have been assured that it is safe to do so.**

**Conditions which can result in transient CO situations:**

- 1) **Excessive spillage or reverse venting of fuel burning appliances caused by outdoor ambient conditions, such as:**
  - i) **Wind direction and/or velocity, including high gusts of wind. Heavy air in the vent pipes (cold/humid air with extended periods between cycles).**
  - ii) **Negative pressure differential resulting from the use of exhaust fans.**
  - iii) **Simultaneous operation of several fuel burning appliances competing for limited internal air.**
  - iv) **Vent pipe connections vibrating loose from clothes dryers, furnaces, or water heaters.**
  - v) **Obstructions in or unconventional vent pipe designs which can amplify the above situations.**
  - vi) **Poorly designed or maintained chimneys and/or vents.**
- 2) **Extended operation of unvented fuel burning devices (range, oven, etc.).**
- 3) **Temperature inversions which can trap exhaust gases near the ground.**
- 4) **Car idling in an open or closed attached garage, or near the building.**

**If SERVICE or low battery signals are activated, see Section 13 for service and return instructions.**

## **11. LIMITATIONS OF CARBON MONOXIDE MONITORS**

Carbon monoxide monitors respond to the presence of CO. They do not detect smoke. If the alarm does activate, follow instructions in Section 10 **WHAT TO DO WHEN THE ALARM SOUNDS**.

Carbon monoxide monitors are devices that can provide an early warning of the presence of CO gas at a reasonable cost. However, monitors have sensing limitations and may not always sound a warning in the presence of CO. The monitor will not operate if the battery power is low or dead. CO monitors must be tested regularly to ensure that they are receiving power and operating properly. Carbon monoxide monitors cannot sense CO that does not reach the monitor, and therefore CO monitors may not detect CO which is in another area of the residence or facility. Furthermore, if the monitor is located on a different level of the building, or on the other side of a closed door, it may not waken a sound sleeper. The use of drugs and alcohol may impair ones ability to hear the alarm. If you have a multi-level building, install CO monitors on each level of the residence or facility. If the monitor is installed in a hallway and the bedroom doors are kept closed at night, also install a CO monitor within each bedroom.

Although CO monitors can help save lives by providing an early warning to the presence of carbon monoxide, they are not a substitute for an insurance policy. Property owners, leaseholders and renters should have adequate insurance to protect everyone's health, lives and property.

## 12. GOOD SAFETY HABITS

### DEVELOP AND PRACTICE A PLAN OF ESCAPE:

Make a floor plan indicating all doors and windows and at least two escape routes from each room.

Have a meeting with everyone to discuss your escape plan, and show what to do in case an alarm sounds.

Determine a place outside your residence or facility where you can all meet if an alarm sounds.

Familiarize everyone with the sound of the alarm and train them to leave the building when they hear it.

Practice a CO fire drill at least once every six months. Practice allows you to test your plan before an emergency. You may not be able to reach everyone. *It is important that they all know what to do.*

Discuss the symptoms related to *CARBON MONOXIDE POISONING* with everyone. (See Section 4 *WHAT ARE THE SYMPTOMS OF CARBON MONOXIDE POISONING?*)

## 13. MONITOR END-OF-LIFE AND SERVICE

After the monitor has been activated for five years, the monitor reaches the end of its life and emits the End-of-Life signal. The monitor will chirp once per minute, **SERVICE** red LED will glow for 3 seconds at the same time, and LCD will continuously display **End**. The monitor must be replaced once the End-of-Life signal has been activated. See below procedures to remove and deactivate the monitor, and discharge the batteries. The monitor can be disposed of using the same method for disposing of discharged batteries.

Should the low battery voltage signal occur in less than five years after initial activation, the battery power capacity may be low because of long-term storage prior to installation, exposure to low or high temperatures or high humidity during storage or operation, or abnormal usage. If the low battery voltage signal is activated in less than three years under normal conditions, press the **TEST/RESET/MUTE** button to mute the audible low battery voltage signal, and place the monitor in an environment at 60°F or warmer. If the low battery voltage signal resumes in 24 hours, follow the steps below to deactivate the monitor, and return the unit for warranty service to the address listed on the last page of this Owner's Manual.

In the event of any malfunction of the unit, the monitor will chirp twice per minute, **SERVICE** red LED will blink for 5 seconds every minute, and LCD will continuously display **Err**. Do not attempt to repair the monitor. This product should be serviced by a qualified service technician. Follow the steps below to deactivate the monitor, and return the unit for warranty service to the address listed on last page of this Owner's Manual.

- To remove the monitor for service or disposal, unscrew the mounting screw from the top center of the monitor, and slide the monitor up and off mounting plate.
- Insert a small flat-head screwdriver into the slot, lift up the deactivation Stop, and slide the switch to farthest left end to deactivate the monitor. The switch moves in one direction only, and cannot be moved back. Once monitor is deactivated, the sealed lithium batteries will be fully discharged and the monitor will no longer work.

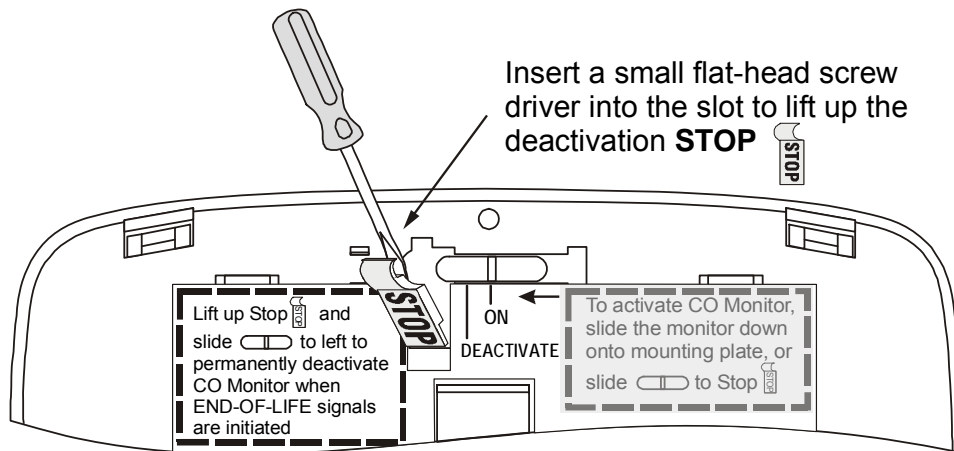

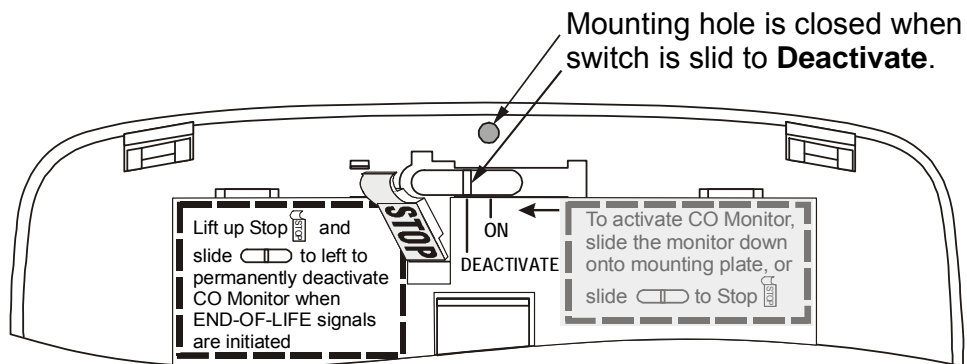

(E) Monitor is activated and “ON” when switch is at **STOP** and mounting hole is open



(F) Monitor is permanently deactivated when switch is moved to left past **STOP** and mounting hole is closed.



# 14. DESCRIPTION OF AUDIBLE AND VISUAL SIGNALS

Condition	LCD Readout	LEDs	Horn
CO monitor is operational	Continuously displays 0 PPM	Green LED flashes once every 60 seconds	Silent
CO gas alert	Displays current CO level detected (see page 5)	<b>ALARM</b> red LED flashes 4 times every minute	Silent
CO gas alarm	Displays current CO level detected (see page 5 for more information about CO display levels)	<b>ALARM</b> red LED flashes 4 times in synchronous with horn	Beeps 4 times, pauses for 5 or 60 seconds. Repeats this pattern for first 5 minutes, then pause time increases to 60 seconds (20 seconds if CO is 150 PPM or more)
Suspend CO alert visual signal	Displays <b>OFF</b> for 5 seconds, then current CO level detected	Flashing red LED suspended for 24 hours. Green LED flashes once per 60 seconds	Silent
Mute CO alarm audible signal	Displays <b>OFF</b> for 5 seconds, then current CO level detected	<b>ALARM</b> red LED continues to flash 4 times every minute	Silent for 12 hours if under 25 PPM, or 5 minutes if 25 PPM or more
Testing monitor	Displays 0 PPM or current CO level detected	<b>ALARM</b> signals are same as CO gas alarm condition, and green LED blinks once when testing complete	Beeps 4 times, pauses for 5 seconds, then beeps 4 times again
Display Memory	Displays highest CO level detected, and duration of peak CO level. Each readout lasts 5 seconds	Green LED blinks once when CO memory display is completed	Silent
Clear Peak Memory	Displays <b>Clr</b>	Green LED blinks once when clear peak memory is completed	Bursts a long beep
Low battery voltage	Displays  symbol	Green LED blinks for 5 seconds every minute	Chirps once per minute
Mute "low battery voltage" audible signal	Displays <b>OFF</b> for 5 seconds, then  symbol and 0 PPM or current CO level detected	Green LED blinks for 5 seconds every minute	Silent for 24 hrs during the first week
"End-of-Life"	Continuously displays <b>End</b>	<b>SERVICE</b> red LED glows for 3 seconds every minute	Chirps once per minute
Mute "End-of-Life" audible signal	Displays <b>OFF</b> for 5 seconds, then <b>End</b>	<b>SERVICE</b> red LED glows for 5 seconds, green LED blinks once, then <b>SERVICE</b> red LED glows for 3 seconds every minute	Silent for 60 hrs during the first month
Service required	Displays <b>Err</b> continuously	<b>SERVICE</b> red LED blinks for 5 seconds every minute	Chirps twice (BEEP-BEEP) per minute

## 15. THREE-YEAR LIMITED WARRANTY

The Defender carbon monoxide monitors are manufactured in Canada under stringent ISO 9001 quality management practices. The manufacturer warrants that, for a period of three years from the date of purchase, this carbon monoxide monitor will be free from defects in material and workmanship, and the factory sealed lithium batteries will power the CO monitor for at least three years. The manufacturer, at its option, will repair or replace this product or any component of the product found to be defective during the warranty period. Replacement will be made with a new or re-manufactured product or component.

If the product is no longer available, replacement may be made with a similar product of equal or greater value. This warranty is valid for the original retail or end-user purchaser from the date of initial purchase and is not transferable. Keep the original sales receipt. Proof of purchase is required to obtain warranty service. Dealers, service centers, or retail stores selling Defender products do not have the right to alter, modify or in any way change the terms and conditions of this warranty.

This warranty does not cover normal wear of parts or damage resulting from any of the following: negligent use or misuse of the product, use contrary to the operating instructions, disassembly, or repair or alteration by anyone other than the manufacturer or an authorized service center. Further, the warranty does not cover acts of God, such as fire, flood, hurricanes and tornadoes.

The manufacturer shall not be liable for any incidental or consequential damages caused by the breach of any express or implied warranty. Except to the extent prohibited by applicable law, any implied warranty of merchantability or fitness for a particular purpose is limited in duration to the duration of the above warranty. Some states or jurisdictions do not allow the exclusion or limitation of incidental or consequential damages or limitations on how long an implied warranty lasts, so the above limitations or exclusion may not apply to you. This warranty gives you specific legal rights, and you may also have other rights that vary from state to state.

### **Warranty Service:**

If service is required, do not return the product to your retailer. Contact Customer Service at (800) 253-1529, Monday through Friday, from 7 AM to 4 PM PST. To assist in serving you, please have the model number, date of purchase, and manufacturing date available when calling. An original sales receipt is required for warranty service.

For warranty service, please obtain a Return Authorization (RA) number, deactivate the monitor per the instructions in Section 13, and mail the monitor to our U.S. representative: Defender Detectors Inc., P.O. Box 60177, Reno, NV 89506

### **For Warranty Service return to:**

To return this product for service, pack carefully in a padded container. Ship prepaid along with original sales receipt, explanation of the problem and your return address to:



**Defender Detectors Inc.**

P.O. Box 60177

Reno, NV 89506

(800) 253-1529

[www.defenderdetectors.com](http://www.defenderdetectors.com)